

# Analysis and Classification Technique Based On ANN for EEG Signals

Neelam Rout

Department of Computer Science and Engineering,  
Institute of Technical Education and Research,  
Siksha 'O' Anusandhan University, Bhubaneswar, India

**Abstract-** This paper presents an ANN approach for classification of EEG signals. Epilepsy is one of the most common and frequent neurological disorders. Actually, epilepsy is a disease of the nervous system, in which the patient falls to the ground in a state of insensibility, with general convulsion of the muscles and bubbling at the mouth. Electroencephalogram (EEG) signal analysis is the main method that is used in epilepsy diagnosis. For seizure detection and prediction by extracting different features of the EEG signal discrete wavelet transformation is used. The proposed approach is found to achieve classification accuracies of 93.62% and 93.08% for the epileptic EEG data.

**Keywords-** Classification of Electroencephalogram (EEG), Committee Neural Network, Artificial Neural Network.

## I. INTRODUCTION

Electroencephalogram (EEG) which is a highly complex signal and it is used to study brain abnormalities. When neurons are activated, the synaptic currents are produced within the dendrites, therefore an EEG signal is a measurement of currents and this current generates a magnetic field over the scalp. There are different types of layers are present in the human head i.e. the scalp, skull, brain and other thin layers (in between), many brain disorders are identified by visual inspection of EEG signals and five brain waves are considered for this i.e. alpha ( $\alpha$ ), theta ( $\theta$ ), beta ( $\beta$ ), delta ( $\delta$ ), and gamma ( $\gamma$ ) [1].

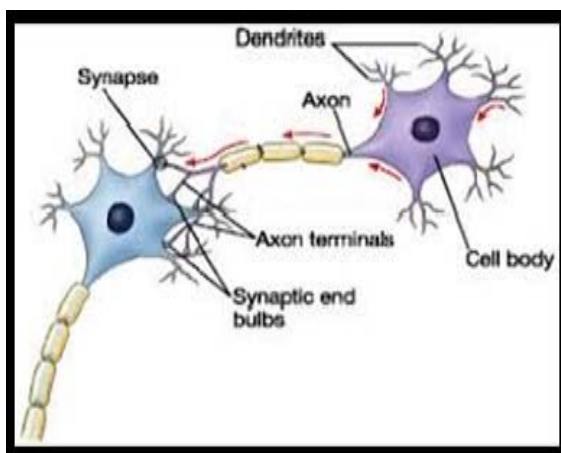

Fig. 1 Structure of neurons

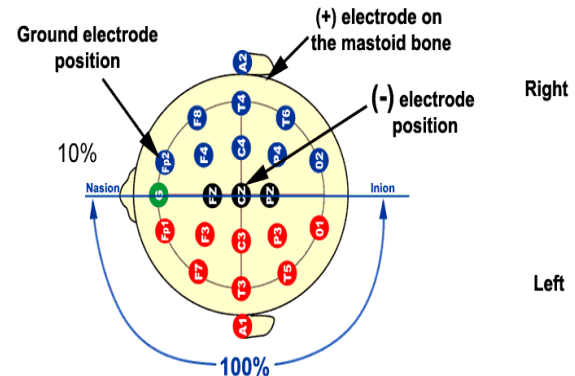

Fig. 2 10-20 EEG electrode positions

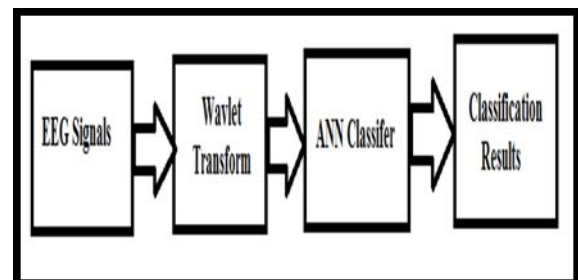

Fig. 3 Schematic illustration of the proposed method

## II. MATERIALS AND METHODS

### A. Data Collection

There are 3 dataset is selected from 5 data set of EEG signals i.e. set a, set d & set e which is available at [3]. In set A EEG signals were recorded from healthy volunteers. In set D recordings were taken from within epileptogenic zone but during seizure free interval and set E contained only seizure activity.

### B. Feature Selection

The Discrete Wavelet Transform (DWT) is a versatile signal processing tool that is used for analyzing the signal at different frequency bands by decomposing the signal into a coarse approximation and detail information. The wavelet coefficients are computed using daubechies wavelet. Order 2 of daubechies wavelet is taken for which the EEG signals are decomposed into details D1-D4 and one approximation A4.

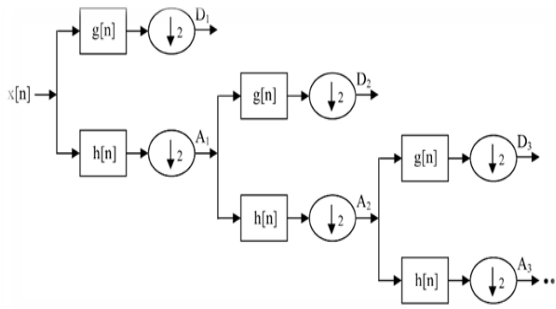

Fig. 4 Discrete wavelet transform block diagram (4)

The four statistical features (Minimum, Maximum, Mean and Standard Deviation) of the EEG are extracted for the neural network.

**III. ARTIFICIAL NEURAL NETWORK**

An Artificial Neural Network, often just called a Neural Network (NN), is a computational model based on biological neural networks. In this supervised learning (the learning signal is the difference between the desired and actual response of the neuron) strategy is used. A neural network is represented by a set of nodes and arrows and in this paper feed forward network is used which has no loop.

The main qualitative characteristics of neural network architectures are as follows:

- Input signal type (dimensionality, discreteness etc.)
- Connection topology
- A goal to maximally increase the operation speed
- Method of performance in time
- Method of connection of independently tuned neural network

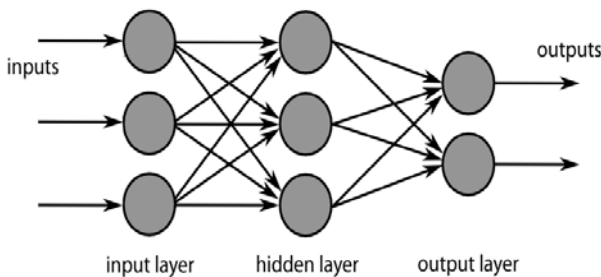

Fig. 5 Feedforward neural network (5)

The basic units of an ANN are neurons and a feed forward back propagating neural network involves supervised learning, in which the output is known from beginning. In this technique, repeatedly adjustment of the weights and biases are done to form output which is close to the expected output as calculated by mean-squared-error (MSE) value. The training algorithms, such as Levenberg-Marquart is used to initialized weights and biases randomly. It is a fast algorithm [6]. When the maximum number of epochs is reached, the training process is stopped and the goal is reached [2].

**C. ANN Design**

- For faulty line detector:

where

$i_0$  = zero sequence current in A;

$i_A, i_B, i_C$  = instantaneous line current in kA;

$V_A, V_B, V_C$  = instantaneous line voltage in kV;

A-g, B-g, C-g = phase to ground fault identification networks;

A-B, B-C, C-A = phase to phase fault identification networks.

- If fault occurrence then output '1' otherwise output '0'.

**IV. COMMITTEE NEURAL NETWORK**

Committee neural network is an approach which has parallel structure that reaps the benefits of its individual members and consists of different neural network that used multilayer perceptron back propagation algorithm.

In back propagation algorithm there are 6 steps.

1. Initialisation

Select  $\eta > 0$ , choose  $E_{max}$  and initialize the weights and offsets at small Random values.

2. Training Starts

- a) Presentation phase
- b) Compute layer outputs (y) in the usual way, by utilizing the correct activation function and weighted sums.

3. Training continues: Checking phase

- a) Checking phase 1
- b) Checking phase 2

4. Training last phase: Learning phase: Weight adjustment, sampling time (k+1)

5. Further pattern application

6. Termination of the training cycle

**V. EXPERIMENTAL RESULTS AND OUTPUTS**

Three types of plots are shown after training the data (plotperform, plottrainingstate & plotregression).

**D. Snapshot of Performance**

The Plotperformance figure shows the best validation performance on some value of epoch. At the time of Mean Squared Error (MSE) of validation samples is started to increase, training is stopped. The plottrainstate figure shows the system state after training based on the default values of different input parameters. Finally, the plotregression figure shows the plot between Output data and training samples, between output data and validation samples and between output data and test samples (R value shows the correlation between output and target values).

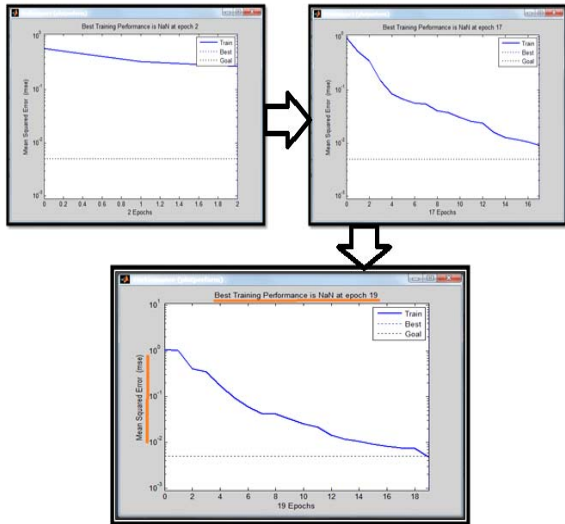

E. Snapshot of Training State

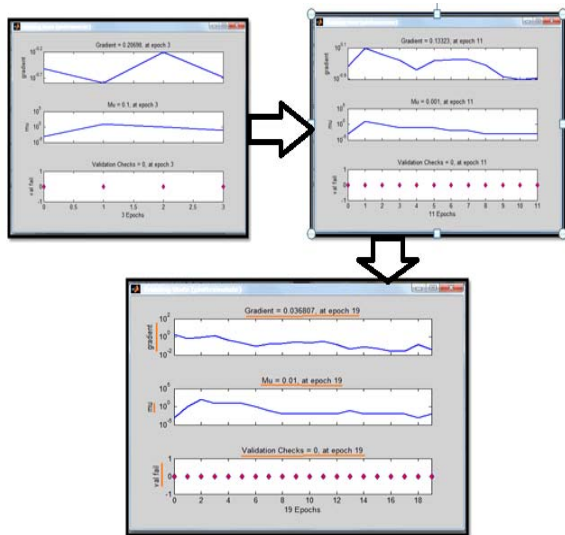

F. Snapshot of Plot Regression

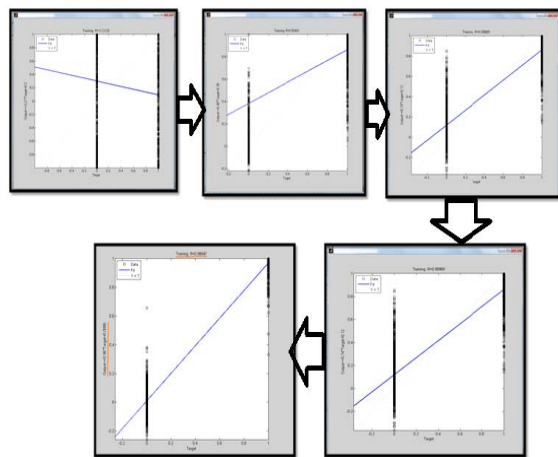

TABLE 1  
CONFUSION MATRIX OF NEURAL NETWORKS

Classifier	Desired Output	Output		
		SET A	SET D	SET E
NN1	SET A	766	28	14
	SET D	14	740	45
	SET E	20	32	741
NN2	SET A	781	41	21
	SET D	10	678	4
	SET E	9	81	775

TABLE 2  
ACCURACY OF CLASSIFICATION

ANN	Accuracy(In percent)
NN1	93.62
NN2	93.08

VI. CONCLUSIONS

We can know invaluable information about the brain function and neurobiological disorders from Electroencephalography (EEG) signals. The proposed method in this paper is used to increase the performance of ANN. The accuracy (in percent) of nn1 & nn2 are 93.62 and 93.08. In the future work to improve the accuracy, three new feature extractions methods based on ANN, CNN and SVM can be used to classify Ictal and Interictal EEG.

ACKNOWLEDGMENT

I would like to express my special appreciation and thanks to my advisor Mr. Sandeep Kumar Satapathy.

REFERENCES

- [1] Saaid Sanei and J.A. Chambers, EEG Signal Processing, John Wiley and Sons Ltd, England, 2007.
- [2] L.M. Patnaik, Ohil K. Manyam, Epileptic EEG detection using neural networks and post-classification, computer methods and programs in biomedicine 91 (2008) 100–109.
- [3] [http://scn.ucsd.edu/~arno/fam2data/publicly\\_available\\_EEG\\_data.html](http://scn.ucsd.edu/~arno/fam2data/publicly_available_EEG_data.html)
- [4] Inan Gler, Elif Derya beyli, Adaptive neuro-fuzzy inference system for classification of EEG signals using wavelet coefficients, Journal of Neuroscience Methods, Volume 148, Issue 2, 30 October 2005, Pages 113-121. Inan Gler, Elif Derya beyli, Adaptive neuro-fuzzy inference system for classification of EEG signals using wavelet coefficients, Journal of Neuroscience Methods, Volume 148, Issue 2, 30 October 2005, Pages 113-121.
- [5] [http://upload.wikimedia.org/wikipedia/commons/c/c2/MultiLayerNeuralNetwork\\_Bigger\\_english.png](http://upload.wikimedia.org/wikipedia/commons/c/c2/MultiLayerNeuralNetwork_Bigger_english.png)
- [6] M.T. Hagan, M.B. Menhaj, Training feedforward networks with the Marquadt algorithm, IEEE Trans. Neural Netw. 5 (1994) 989–993.
- [7] Abdulhamit Subasi, Epileptic seizure detection using dynamic wavelet network, Expert Systems with Applications 29 (2005) 343–355.
- [8] Umud Orhan, Mahmut Heki, Mahmut Ozer, EEG signals classification using the K-means clustering and a multilayer perceptron neural network model, Expert Systems with Applications 38 (2011) 13475–13481.
- [9] Mahmut HEKIM, ANN-based classification of EEG signals using the average power based on rectangle approximation window, PRZEGLAD ELEKTROTECHNICZNY (Electrical Review), ISSN 0033-2097, R. 88 NR 8/2012.
- [10] Pari Jahankhani, Vassilis Kodogiannis and Kenneth Revett, EEG Signal Classification Using Wavelet Feature Extraction and Neural Networks, IEEE John Vincent Atanasoff 2006 International Symposium on Modern Computing (JVA'06).